

EZTP Series

EXPLOSION PROOF EXIT SIGN BATTERY BACKUP

SPECIFICATIONS

- VOLTAGE:** 100-277VAC
WATTAGE: 5W (Standard), 3W
LED EXIT SIGN COLORS: Red (Standard), Green
OPERATING TEMP: - 40°F to 140°F (-40°C to 60°C)
BATTERY HOUSING: Die-cast A356T6 Aluminum(Copper-free) Baked-on gray epoxy finish
SIGN PANEL: Tempered Glass (with dual chevrons STD) (consult factory for alternate configurations)
HARDWARE: Stainless Steel
CRI: >70
EMERGENCY MODE: 3 Hours
MOUNTING: Wall and pendant mounting standard. 3/4" NPT hubs provided for conduit feed
PROTECTION: IP66 & IK10/IK08
WARRANTY: 5 Year Limited Warranty

CERTIFICATIONS

- Class I, Division 1 Groups B, C, D
- Class I, Division 2 Groups A, B, C, D
- Class II, Division 2 Groups F, G
- Class III
- UL844 - Hazardous Locations
- UL924 - Emergency Lighting

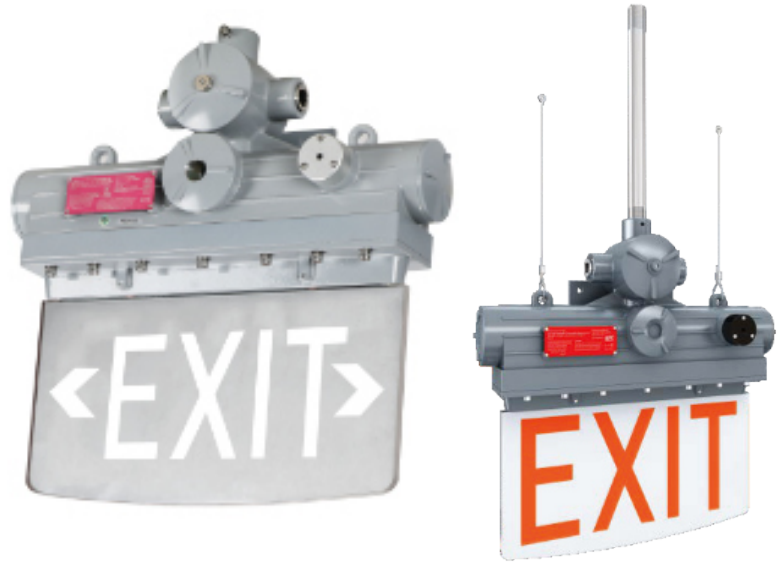

DIMENSIONS

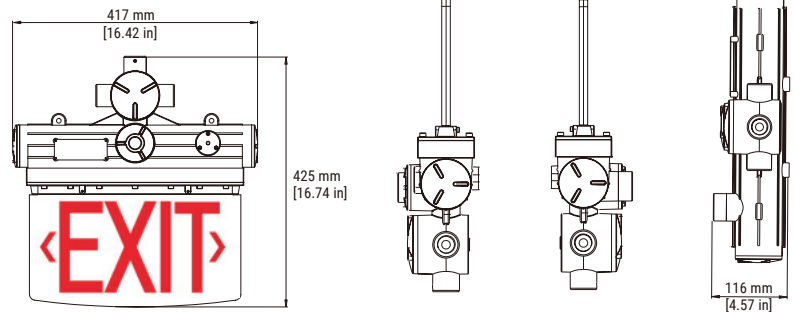

WEIGHT: 13.2 lbs (6 kg)

ORDERING INFORMATION

ORDERING GUIDE

Series	Wattage	LED Color	Panel Face	Voltage	Chevrons	Options
EZTP	3 = 3W 5 = 5W (Standard)	RD = Red (Standard) GN = Green	SF = Single Face (Clear) DF = Double Face (White)	LV = 100-277V	DA = Double Arrow LA = Arrow Left RA = Arrow Right RL = Right/Left Arrow <i>Double-faced Only</i> NA = No Arrow	WM = Wall Arm Mount PNT = Pendant Mount CS = Custom Wording

* Mounting options please refer to the accessories at the bottom of page 2

REPLACEMENT PANELS

Series	Panel Face	Chevrons
EZTP	SF = Single Face (Clear) DF = Double Face (White)	DA = Double Arrow LA = Arrow Left RA = Arrow Right RL = Right/Left Arrow <i>Double-faced Only</i> NA = No Arrow

MOUNTING

Surface/Wall mount Bracket
STANDARD MOUNT

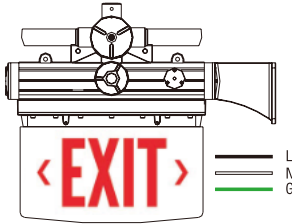

Pendant Mount

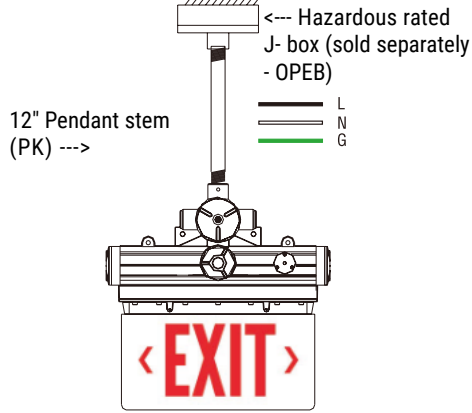

MOUNTING INSTRUCTIONS

Wall Mounting with Arm

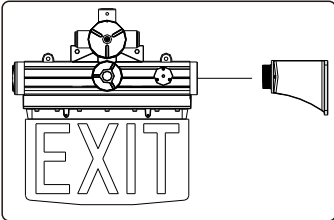

1. Tighten the arm to the fixture.

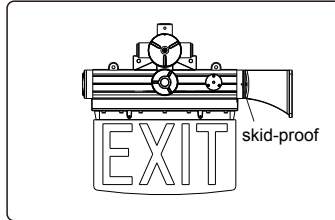

2. Tighten the screw of skid-proof.

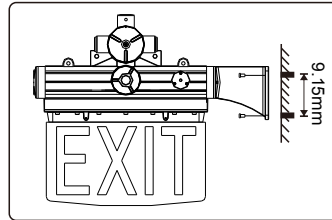

3. Drill 2 holes(Ø10mm) for arm.

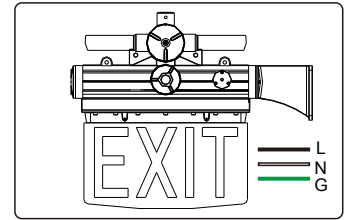

4. Wiring the cable as white L, black to N, green to G.

Pendant Mounting

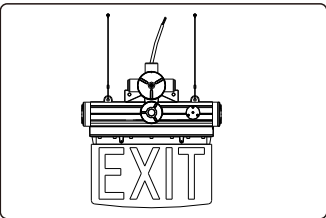

1. Tighten the arm to the fixture.

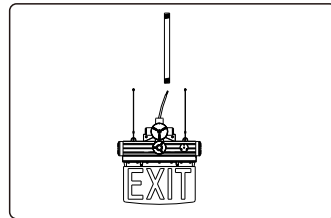

2. Install the cable through the pole.

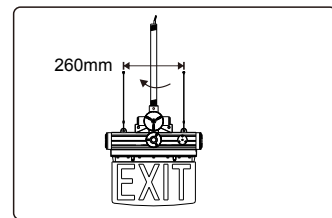

3. Drill 2× holes(Ø10mm) for metal wires and tighten the screw of skid-proof.

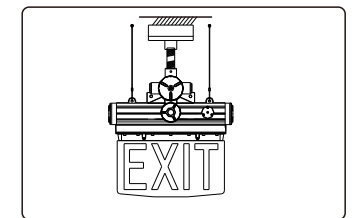

4. Install the junction box. Wiring the cable as white black to N, green to G.