

EMPS Series Inverters

Emergency Micro Power Systems

STANDARD

OPTIONAL



DESCRIPTION

- EMPS Series inverter systems are designed to provide sinusoidal AC emergency power to connected incandescent, fluorescent or LED fixtures of between 20 and 55 watts.
- Surface, recessed or ceiling T-Grid mount models are designed for easy installation either on or near controlled fixtures. MPS models support Normally-ON, Normally-OFF, switched operation or any combination thereof (see wiring diagram).

ELECTRICAL SPECIFICATIONS

Input

- Input Voltages: 120 or 277VAC $\pm 10\%$
- Input Frequencies: 60Hz $\pm 2\%$
- Input Protection: Provided by Service Panel, Rated 20A max.

Output

- Output Voltages: 120 or 277VAC (60Hz)
- Efficiency Rating: 98% at full rated load (line)
- Waveform: Sinusoidal (digitally controlled, PWM design)
- Static Voltage: $\pm 5\%$ during battery discharge. 0-100% linear load.
- Output Frequencies: 60Hz. ± 0.3 Hz during emergency cycle
- Output Distortion: Less than 3% THD (linear load)
- Transfer Time: Less than 1.0 second
- Load Power Factor Range: 0.44 Lead to 0.44 Lag
- Minimum Loading: 0% of rated system capacity
- Output Protection: Inverter fuse

HOUSING

- Heavy duty steel cabinet is finished in white baked-on powder paint providing scratch and corrosion resistance.
- Optional paint color (-SP) finishes available, consult factory.

Optional Ceiling T-grid Mount Housing

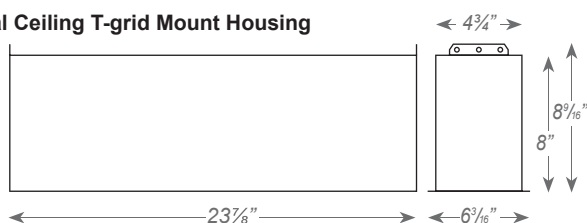

True Sinusoidal Output Power



Surface Mount Models

MOUNTING

- Surface Mount:** Surface mount models are designed for mounting to walls by means of keyhole slots provided in the back of the unit housing.
- Recess Mount:** Recess models provide recess mounting holes on both sides of the enclosure.
- T-Grid Mount:** Housing design allows simple drop-in installation between t-grid runs. Safety wires (supplied by others) are required for attachment to building structure.

WARRANTY / LISTING

- Unit:** (excluding lamps) Full coverage against defects in materials and workmanship for 3 years from date of shipment.
- Battery:** 3 years Lead-Acid, 5 yrs NiCd full warranty plus an additional 7 years of pro-rata coverage.
- All models are UL924 Listed and meet NFPA 101 Life Safety Code, NEC, OSHA, Local and State Codes. Optional T-Grid models are plenum rated, to UL2043 and meets city of Chicago CCEA Requirements.
- UL Listed for damp locations (0°– 50°C for NiCad models and 20°– 30°C for lead-calcium models).
- Optional -CEC models are Certified to CEC Under Title 20 regulations
- FCC Part 15 Class B Compliant.

DIMENSIONS

Standard Surface Mount Housings

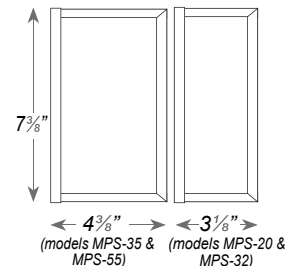
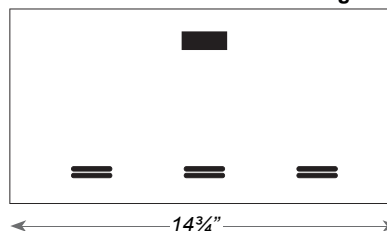

Recessed Mount Housings

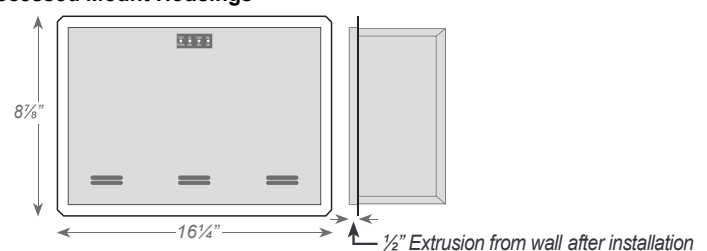

The EMPS Series is designed to provide 20W to 55W of emergency power to incandescent, fluorescent, and/or LED fixtures. The EMPS unit provides clean, sinusoidal AC output power allowing it to be remotely mounted up to 1,000 feet away from the controlled fixture(s).

Unlike a ballast fluorescent emergency pack, the EMPS provides power to the input side of the fixture, (including the ballast) eliminating any chance of incompatibility. EMPS Series models are available for surface, recessed or ceiling T-Grid mounting if required. All EMPS systems will provide emergency power output for a minimum of 90-minutes.



FEATURES

- For powering incandescent, fluorescent, and LED fixtures *
- True sinusoidal AC pulse width modulated (PWM) design provides clean 60Hz. emergency output
- Universal 120/277VAC, 60Hz. input/output
- Unit capacities of 20W to 55W
- "Soft Start" design reduces fixture inrush current
- Surface, recessed or T-Grid mount models
- Lumen output from fixture is 100% of nominal
- Unique design eliminates compatibility problems with LED drivers as well as fluorescent ballasts
- Normally-ON and/or Normally-OFF load output
- Provisions for local switching capability - Always-ON during emergency conditions regardless of local switch position
- Temperature compensated, dual-mode charger includes low voltage disconnect feature to provide protection against battery deep discharge
- Maintenance-free Lead-Calcium and premium grade Nickel-Cadmium battery models offered
- Control panel with momentary test switch, AC-ON, Charge-ON and Inverter-ON LED indicators
- Battery circuit fuse protected
- Reverse battery and AC lockout protection

* Consult factory for compatibility for other lamp types

GENERAL SPECIFICATIONS

MODEL NUMBER	HOUSING SIZE	INPUT / OUTPUT VOLTS	90 min. CAPACITY (Watts/VA)	SYSTEM WEIGHT*		BATTERY TYPE	TEMP. RANGE (°C)	POWER CONSUM. (Max.)	BATTERY VOLTAGE (VDC)	DC INPUT CURRENT (Adc)	INPUT CURRENT		THERMAL OUTPUT in BTUs	
				Lbs.	Kg.						120VAC (max)	277VAC (max)	STANDBY	EMERGENCY
EMPS-32	Small	120/277	32/32	14.0	6.4	Lead-Calc	20-30°	9W	12	3.4	0.34A	0.15A	7	32
EMPS-55	Large	120/277	55/55	18.0	8.2	Lead-Calc	20-30°	9W	12	5.7	0.54A	0.23A	7	47
EMPS-20	Small	120/277	20/20	11.0	5.0	NiCad	0-50°	9W	12	2.1	0.25A	0.11A	31	22
EMPS-35	Large	120/277	35/35	12.0	5.4	NiCad	0-50°	9W	12	3.8	0.37A	0.16A	31	35

07.2019 * System weights shown include installed batteries

WIRING

Connection to an unswitched AC circuit is required by the NEC. Wiring access is provided for by conduit knockouts in the unit housing. EMPS Series models also provide knockouts in the back of the housing for rear wiring from standard electrical boxes when surface mounting.

LOAD COMPATIBILITY

EMPS model's clean, sinusoidal AC output will operate incandescent lamps as well as all common fluorescent and LED lamp types. Consult factory for compatibility with all other lamp types.

Lighting loads are driven at 100% output for the entire emergency power cycle. This outstanding feature translates into greater occupant egress vision and safety.

SYSTEM OPTIONS ^{(1) (2)}

ADD SUFFIX	DESCRIPTION
-S	Surface Mount Housing
-R	Recess Mount Housing
-T	Plenum Rated Ceiling T-Grid Mount Housing
-SP	Special Housing Color (specify)
-RTS	Remote Test Switch Panel ⁽³⁾
-SDT	Self-Testing / Self-Diagnostics ⁽³⁾
-CEC	Title 20 Compliant

(1) Other options available. Consult factory.

(2) Some options may impact product UL listing. Consult factory.

(3) For more information, separate specification sheets are available on the -RTS and -SDT options. Consult factory.

BATTERIES AND CHARGE

Battery

Battery: Sealed Lead Calcium (10 year life) or Sealed Nickel-Cadmium (15 year life)

Battery Voltage: 12VDC for all EMPS models

Runtime: 90-minutes standard. Other run times available, consult factory.

Battery Protection: Low Voltage Battery Disconnect protects the battery from being severely damaged by deep discharge during prolonged power failures.

DC Overload and Short Circuit Protection provided by a DC input fuse.

Charger

Charger Type: Fully automatic, temperature compensated, dual-mode charger

Power Consumption: 9W max. (All models)

Recharge Duty Cycle: Meets UL924 requirements

Controls: Momentary test switch, AC-ON, Charge-ON and Inverter-ON LED indicator lights

Safety Circuitry: AC Lockout prevents battery discharge prior to initial unit power-up.

Brownout Protection automatically switches the unit to emergency mode when utility voltage is significantly reduced.

Environmental

Altitude: < 10,000 feet (3,000m) above sea level without derating.

Operating Temperature Range:

Lead-Calcium Models: 20°C to 30°C

Nickel-Cadmium Models: 0°C to 50°C

NOTE: Optimum system performance between 20°C and 30°C; temperatures outside of this range will affect battery performance and life.

Relative Humidity: 95% non-condensing

OPERATION

Upon failure of the normal utility power the EMPS unit is automatically turned on by a solid-state switching circuit and provides a minimum of 90-minutes of emergency power to the connected load. Lumen output will be maintained at 100% of the lamp's rating throughout the entire duration.

A solid-state low voltage disconnect circuit is used to protect the battery from being severely damaged by a deep discharge. When normal utility power is restored, the unit switches the load back to normal utility operation and the fully automatic, temperature compensated, dual mode charger begins to restore the battery; bringing it to full charge within UL924 specified parameters. A brownout sensing circuit insures proper operation during "low line" conditions.

SYSTEM STATUS MONITORING PANEL

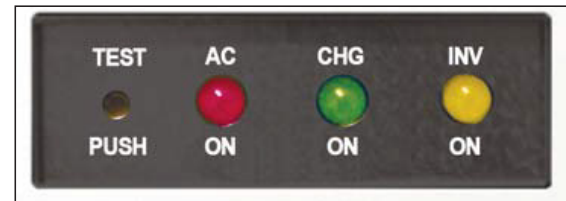

All EMPS systems provide a monitoring panel on the front of the unit to show operating status at all times. The panel provides a test switch for user initiated system tests and a 3-LED array that provides an intuitive visual indication of unit readiness.

IMPROVED AESTHETICS

The EMPS system's sinusoidal AC output design eliminates voltage drop and proximity concerns. This allows added flexibility in installation location as EMPS units can be installed hundreds of feet from the units they power. This means EMPS units to be located conveniently out of sight in closets or utility rooms without interrupting architectural aesthetics.

In lighting applications, no special or additional emergency fixtures are necessary. Simply designate and connect existing lighting fixtures either interior or exterior, to the EMPS unit for emergency operation eliminating the need for exposed, stand-alone emergency luminaires.

EMPS SYSTEM ADVANTAGES

Compared to traditional discrete emergency lighting units, the EMPS Series provides emergency illumination from a single power source resulting in lower maintenance overhead and routine testing expenses.

EMPS units lower installation costs by powering existing lighting fixtures during emergencies. And because connected fixtures are driven at full brilliancy, they provide far superior egress lighting and deliver improved occupant safety.

SUGGESTED SPECIFICATIONS

An inverter system with sinusoidal output shall be supplied capable of powering any combination of lighting fixtures, including incandescent fluorescent, induction and/or LED light sources without compatibility problems.

The system shall transfer in less than 1.0 second to reliably back up lighting fixtures without loss of illumination and operate any and all connected lighting fixtures at full lumen output during the complete 90-minute discharge cycle.

System shall be capable of providing, remote test switch, and self-test/self-diagnostics, were necessary. System shall utilize a sealed lead calcium battery with a 10 year design life or a sealed Nickel-Cadmium battery with a 15 year design life. The charger shall be temperature compensated, dual mode type, and recharge the batteries as per UL924 guidelines. Entire system shall be tested, approved, and labeled to UL924 Emergency Lighting and Power Systems standards. T-Grid models will be plenum rated.

System shall be capable of providing, remote test switch, and self-test/self-diagnostics, were necessary. System shall utilize a sealed lead calcium battery with a 10 year design life or a sealed Nickel-Cadmium battery with a 15 year design life. The charger shall be temperature compensated, dual mode type, and recharge the batteries as per UL924 guidelines. Entire system shall be tested, approved, and labeled to UL924 Emergency Lighting and Power Systems standards. T-Grid models will be plenum rated.

WIRING DIAGRAMS

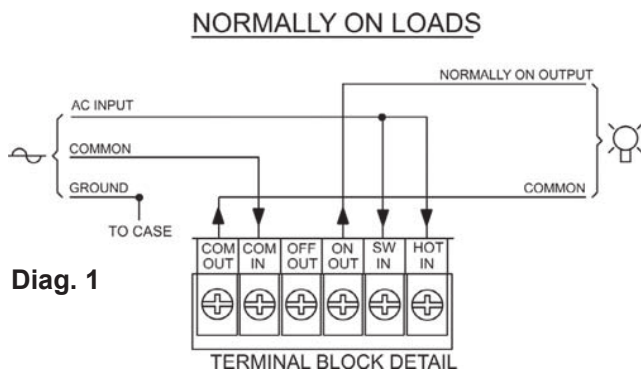

Diag. 1

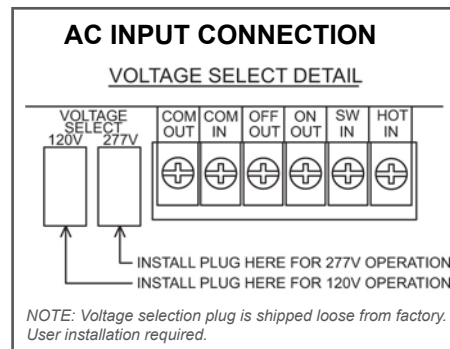

NORMALLY OFF LOADS

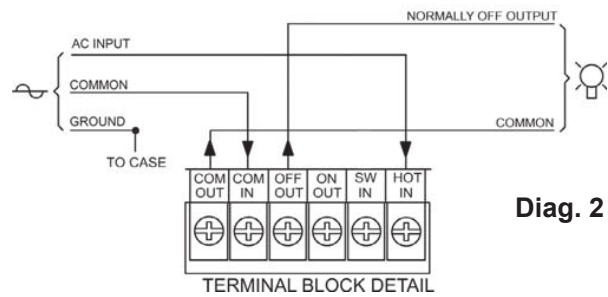

Diag. 2

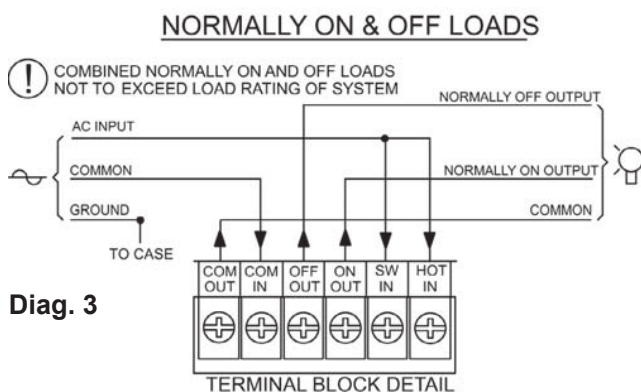

Diag. 3

SWITCHED LOADS

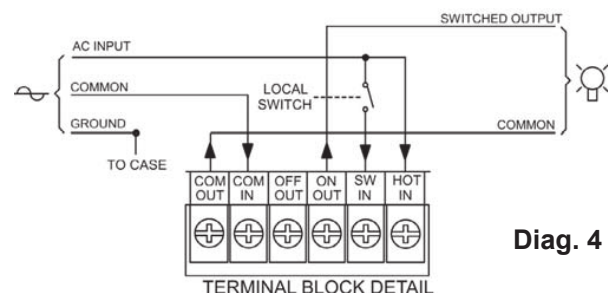

Diag. 4